

, 5-pole, Socket, PCB terminals, DIN Plug/Socket



5-pole

See below:

Approvals and Compliances

Description

- PCB :
- Screw-on mounting , rear-side
- DIN Plug: 5-pole , straight

Weblinks

[pdf data sheet](#), [html datasheet](#), [General Product Information](#), [Distributor-Stock-Check](#), [Detailed request for product](#)

Technical Data

Diameter	9.0 mm	Allowable Operation Temperature	-20 °C to 70 °C
Number of Poles	5-pole	Terminal	PCB terminals silver plated
Ratings DC	1 A / 12VDC	Mounting	Screw-on mounting wall thickness max. 2.0mm
Ratings AC	1 A / 100VAC	Lifetime	5000 Insertions
Dielectric Strength	250VAC		
Insulation Resistance	> 50 MΩ @ 250VDC		

Approvals and Compliances

Detailed information on product approvals, code requirements, usage instructions and detailed test conditions can be looked up in [Details about Approvals](#)

SCHURTER products are designed for use in industrial environments. They have approvals from independent testing bodies according to national and international standards. Products with specific characteristics and requirements such as required in the automotive sector according to IATF 16949, medical technology according to ISO 13485 or in the aerospace industry can be offered exclusively with customer-specific, individual agreements by SCHURTER.

Compliances

The product complies with following Guide Lines

Identification	Details	Initiator	Description
	RoHS	SCHURTER AG	Directive RoHS 2011/65/EU, Amendment (EU) 2015/863
	China RoHS	SCHURTER AG	The law SJ / T 11363-2006 (China RoHS) has been in force since 1 March 2007. It is similar to the EU directive RoHS.
	REACH	SCHURTER AG	On 1 June 2007, Regulation (EC) No 1907/2006 on the Registration, Evaluation, Authorization and Restriction of Chemicals 1 (abbreviated as "REACH") entered into force.

Dimensions [mm]

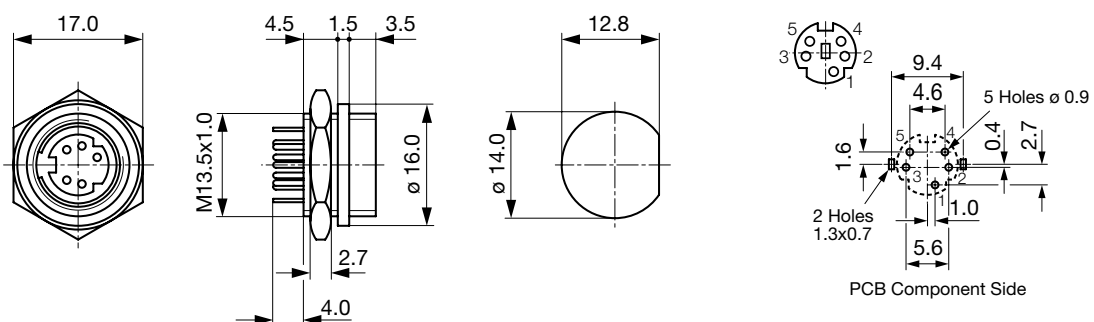

All Variants

Product group	Diameter [mm]	Number of Poles	Terminal	Order Number
DIN Plug/Socket	9.0	5-pole	PCB terminals	4850.2500

Availability for all products can be searched real-time: <https://www.schurter.com/en/info-center/support-tools/stock-check-distributors>

Packaging unit	250 Pcs
-----------------------	---------

Mating Inlets/Plugs

Category / Description



[DIN Plugs / Sockets Overview complete](#)

, 5-pole, Plug, solder terminal, DIN Plug/Socket

4850.1510